

Technical Report No.: 64.181.22.03449.01 Rev.00

Date: 2022-09-20

Client: Report holder's name: Guangzhou Sprsun New Energy Technology Development Co., Ltd
 Report holder's Address: No.15 Tangxi Road, Yinsha Industrial Park, Xintang, Zengcheng District,Guangzhou,511338, China
 Contact person of report holder: YE XIN
 Manufacturer's name: Guangzhou Sprsun New Energy Technology Development Co., Ltd
 Manufacturer's address: No.15 Tangxi Road, Yinsha Industrial Park, Xintang, Zengcheng District,Guangzhou,511338, China

Factory: Factory's name: Guangzhou Sprsun New Energy Technology Development Co., Ltd
 Factory's address: No.15 Tangxi Road, Yinsha Industrial Park, Xintang, Zengcheng District,Guangzhou,511338, China

Test object: Product: EVI DC Inverter Air Source Heat Pumps
 Model: CGK-025V3L; CGK-030V3L-B; CGK-040V3L; CGK-050V3L-B
 Trade name: SPRSUN

Test specification: EN 14825:2018
 (EU) No 813/2013
 EN 14511-3:2018
 EN 14511-4:2018 Clause 4
 EN 12102-1:2017

Purpose of examination: Test according to the test specification
 EU 2016/2282:2016-11-30

Test result: The test results show that the presented product is in compliance with the above listed test specifications.

Any use for advertising purposes must be granted in writing. This technical report may only be quoted in full. This report is the result of a single examination of the object in question. It does not imply a general statement regarding the quality of products from regular production. For further details please see testing and certification regulation, chapter A-3.4.

Doc No.: ITC-TTW0902.02E – Rev.11

1 Description of the test object

1.1 Function

Manufacturer's specification for intended use:
 These appliances are air to water heat pump.
 Manufacturer's specification for predictive use:
 According to user manual.

1.2 Consideration of the foreseeable use

- Not applicable
- Covered through the applied standard
- Covered by the following comment
- Covered by attached risk analysis

1.3 Technical Data

Model :	CGK-025V3L; CGK-030V3L-B; CGK-040V3L; CGK-050V3L-B
Rated Voltage (V) :	380-420V, 3N~
Rated Frequency (Hz) :	50Hz
Rated Power (W) :	3000 for CGK-025V3L; 3940 for CGK-030V3L-B; 4900 for CGK-040V3L; 6290 for CGK-050V3L-B
Rated Current (A) :	6.30 for CGK-025V3L; 8.31 for CGK-030V3L-B; 10.40 for CGK-040V3L; 13.28 for CGK-050V3L-B
Protection Class :	Class I
Protection Against Moisture :	IP X4
Construction :	Stationary
Supply connection :	<input type="checkbox"/> Non detachable cord <input checked="" type="checkbox"/> Permanent connection to fixed wiring
Operation mode:	<input checked="" type="checkbox"/> Continuous operation; <input type="checkbox"/> Intermittent operation; <input type="checkbox"/> Short time operation;
Refrigerant/charge (g) :	R32 / 1500g for CGK-025V3L; 1700g for CGK-030V3L-B; 2000g for CGK-040V3L; 2800g for CGK-050V3L-B
Declared parameters :	<input checked="" type="checkbox"/> Average <input type="checkbox"/> Warmer <input type="checkbox"/> Colder
Sound power level dB(A) :	N/A
Series No :	KRZK07A20250703577 for CGK-025V3L; KRZJ09A20300801957 for CGK-030V3L-B; KRZK07A20400703827 for CGK-040V3L; KRZJ09A20500802377 for CGK-050V3L-B

2 Order

2.1 Date of Purchase Order, Customer's Reference

2022-08-15, Guangzhou Sprsun New Energy Technology Development Co., Ltd

2.2 Test Sample(s)

- Reception date(s): 2022-08-15,
- Location(s) of reception:

For Energy test:

Guangzhou Lingxin Technology Co., LTD

Address: Room 101, Building 2, No.13 west Route, Kengtou Industrial Zone, Nancun Town, Panyu District, Guangzhou

For Noise tests:

CVC Testing Technology Co., Ltd.

Address: No.3, Tiantaiyi Road, Kaitai Avenue, Science City, Guangzhou, Guangdong, 510663, P.R.China

- Condition of test sample(s): completed and can be normal operation

2.3 Date(s) of Testing

2022-08-15 to 2022-09-19

2.4 Location(s) of Testing

Same as 2.2

2.5 Points of Non-compliance or Exceptions of the Test Procedure

N/A

3 Test Results

3.1 Positive Test Results

See Appendix I

4 Remark

N/A

- 4.1** The user manual has been examined according to the minimum requirements described in the product standard. The manufacturer is responsible for the accuracy of further particulars as well as of the composition and layout.
- 4.2** When the product is placed on the market, it must be accompanied with safety Instructions written in official language of the country. The instructions shall give information re-garding safe operation, installation and maintenance.

5 Documentation

- Appendix I Test results
- Appendix II Marking plate
- Appendix III photo documentation
- Appendix IV Construction data form
- Appendix V Test equipment list

6 Summary

- 1) These appliances are Air to Water Heat Pump Unit, each one including a whole compression type refrigerant circuit to heat water in another circuit. These appliances were for cooling and heating water function, this report only for heating capacity test.
- 2) The main power is supplied by a 5-pole supply cord connecting to fixed wiring.
- 3) Water enthalpy method was adopted in this report.
- 4) Standby mode power, off mode power and thermostat-off mode power were tested according to clause 12 of standard EN 14825:2018.

**TÜV SÜD Certification and Testing (China) Co., Ltd. Guangzhou Branch
TÜV SÜD Group**

Tested by: William Liang, Project Handler *William . Liang*
printed name, function & signature

Approved by: Plum Li, Designated Reviewer *Plum Li*
printed name, function & signature



Doc No.: ITC-TTW0902.02E – Rev.11

Appendix I Test results

Table 1.	Heating mode(Low temperature application):						P	
Model	CGK-025V3L							
Product type	Air to Water	Heating season	<input checked="" type="checkbox"/>	Average	<input type="checkbox"/>	Warmer	<input type="checkbox"/>	Colder
1. Test conditions:								
Condition	Part Load Ratio in %				Outdoor heat exchanger	Indoor heat exchanger		
	Formula	A	W		Inlet dry (wet) bulb temperature °C	Inlet/outlet water temperatures (°C)		
A	$(-7-16)/(T_{designh-16})$	88	N/A	N/A	-7(-8)	a / 34		
B	$(+2-16)/(T_{designh-16})$	54	N/A	N/A	2(1)	a / 30		
C	$(+7-16)/(T_{designh-16})$	35	N/A	N/A	7(6)	a / 27		
D	$(+12-16)/(T_{designh-16})$	15	N/A	N/A	12(11)	a / 24		
E	$(TOL-16)/(T_{designh-16})$				TOL	a / 35.3		
F	$(T_{bivalent-16})/(T_{designh-16})$				T _{biv}	a / 34		
G	$(-15-16)/(T_{designh-16})$	N/A	N/A	N/A	-15	N/A		
Remark: a) With the water flow rate as determined at the standard rating conditions given in EN14511-2 at 30/35 conditions, the capacity is 7879.62W, the power is 1697.79W, the COP is 4.64W/W.								
2. Tested data/correction data(Average):								
General test conditions/ Part-Load	Unit	A(-7)/W34 (88%)	A2/W30 (54%)	A7/W27 (35%)	A12/W24 (15%)	A(-10)/W35.3 (100%)	A(-7)/W34 (88%)	
	--	A	B	C	D	E	F	
Data collection period	hh: min:sec	4:00:00	2:10:00	2:10:00	2:10:00	4:00:00	4:00:00	
The heat pump defrosts	--	Yes	No	No	No	Yes	Yes	
Complete Cycles	--	2	0	0	0	2	2	
Barometric pressure	kPa	101.02	101.02	101.02	101.02	101.02	101.02	
Voltage	V	401.3	400.6	399.0	397.9	400.9	401.3	
Current input of the unit	A	4.96	2.65	2.25	1.93	5.05	4.96	
Power input of the unit	kW	2.047	0.895	0.705	0.555	2.073	2.047	
Test conditions indoor unit								
Inlet Water temperature, DB	°C	29.36	27.33	24.33	20.76	30.99	29.36	
Outlet Water temperature, DB	°C	33.27*	29.98	27.15	23.96	34.51*	33.27*	

Doc No.: ITC-TTW0902.02E – Rev.11

Appendix I Test results

Test conditions outdoor unit							
Air inlet temperature, DB	°C	-6.97	2.03	7.00	12.01	-10.00	-6.97
Air inlet temperature, WB	°C	-8.11	1.01	6.00	11.00	-11.11	-8.11
Summary of the results							
Total heating capacity	kW	6.135	4.154	4.433	5.036	5.511	6.135
Effective power input	kW	2.079	0.927	0.737	0.587	2.105	2.079
Coefficient of performance (COP)	--	2.95	4.48	6.01	8.58	2.62	2.95
Compressor frequency	Hz	70	33	30	30	70	70
Water flow	m³/h	1.35	1.35	1.35	1.35	1.35	1.35

Remark: * In part condition, outlet temperature data is recorded by a full average complete cycle's data.

3.Calculation/conclusion for SCOP(Average):

Tdesignh(°C)	-10	Tbiv(°C)	-7
Pdesignh(kW)	6.935	TOL(°C)	-10

Test result A, B, C, D, E, F conditions:

Condition	Part load	Measured capacity	COP at measured capacity	Cdh	CR	COP at part load
E	6.935	5.511	2.62	0.00	1.00	2.62
F	6.135	6.135	2.95	0.00	1.00	2.95
A	6.135	6.135	2.95	0.00	1.00	2.95
B	3.734	4.154	4.48	0.99	0.90	4.47
C	2.400	4.433	6.01	0.99	0.54	5.96
D	1.067	5.036	8.58	0.99	0.21	8.27

CR: part load divided by capacity;

Doc No.: ITC-TT0902.02E – Rev.11

Appendix I Test results

Electric power consumptions	Unit	Value
Thermostat-off mode [P_{TO}]	kW	0.017
Standby mode [P_{SB}]	kW	0.017
Crankcase heater [P_{CK}]	kW	0.029
Off mode [P_{OFF}]	kW	0.017

Conclusions:	Unit	Value
SCOPon:	kWh/kWh	4.63
SCOP:	kWh/kWh	4.62
Q_H :	kWh/year	14327
Q_{HE} :	kWh/year	3102
$\eta_{s,h}$	%	181.8
Seasonal space heating energy efficiency classes: (According (EU) No 811/2013 Table 2)	--	A+++

Appendix I Test results

Table 2.	Heating mode(Medium temperature application):						P
Model	CGK-025V3L						
Product type	Air to Water	Heating season	<input checked="" type="checkbox"/> Average	<input type="checkbox"/> Warmer	<input type="checkbox"/> Colder		
1. Test conditions:							
Condition	Part Load Ratio in %				Outdoor heat exchanger	Indoor heat exchanger	
	Formula	A	W	C	Inlet dry (wet) bulb temperature °C	Inlet/outlet water temperatures (°C)	
A	$(-7-16)/(T_{designh-16})$	88	N/A	N/A	-7(-8)	a / 52	
B	$(+2-16)/(T_{designh-16})$	54	N/A	N/A	2(1)	a / 42	
C	$(+7-16)/(T_{designh-16})$	35	N/A	N/A	7(6)	a / 36	
D	$(+12-16)/(T_{designh-16})$	15	N/A	N/A	12(11)	a / 30	
E	$(TOL-16)/(T_{designh-16})$				TOL	a / 55.3	
F	$(T_{bivalent-16})/(T_{designh-16})$				Tbiv	a / 52	
G	$(-15-16)/(T_{designh-16})$	N/A	N/A	N/A	-15	N/A	
Remark: a) With the water flow rate as determined at the standard rating conditions given in EN14511-2 at 47/55 conditions, the capacity is 7972.01W, the power is 2790.13W, the COP is 2.86W/W.							
2. Tested data/correction data(Average):							
General test conditions/ Part-Load	Unit	A(-7)/W52 (88%)	A2/W42 (54%)	A7/W36 (35%)	A12/W30 (15%)	A(-10)/W55.3 (100%)	A(-7)/W52 (88%)
	--	A	B	C	D	E	F
Data collection period	hh: min:sec	4:00:00	2:10:00	2:10:00	2:10:00	2:10:00	4:00:00
The heat pump defrosts	--	Yes	No	No	No	No	Yes
Complete Cycles	--	1	0	0	0	0	1
Barometric pressure	kPa	101.02	101.02	101.02	101.02	101.02	101.02
Voltage	V	400.7	401.7	401.0	402.0	403.4	400.7
Current input of the unit	A	6.80	3.15	2.76	2.40	6.70	6.80
Power input of the unit	kW	2.956	1.176	0.924	0.716	3.069	2.956
Test conditions indoor unit							
Inlet Water temperature, DB	°C	44.67	37.84	31.89	25.14	48.14	44.67
Outlet Water temperature, DB	°C	51.27	41.81	36.15	30.01	54.46*	51.27

Doc No.: ITC-TTW0902.02E – Rev.11

Appendix I Test results

Test conditions outdoor unit							
Air inlet temperature, DB	°C	-6.93	2.02	7.00	12.00	-10.00	-6.93
Air inlet temperature, WB	°C	-8.13	1.00	6.00	11.00	-11.22	-8.13
Summary of the results							
Total heating capacity	kW	6.532	4.007	4.313	4.932	6.336	6.532
Effective power input	kW	2.996	1.216	0.964	0.756	3.109	2.996
Coefficient of performance (COP)	--	2.18	3.29	4.48	6.52	2.04	2.18
Compressor frequency	Hz	70	33	30	30	70	70
Water flow	m³/h	0.87	0.87	0.87	0.87	0.87	0.87
Remark: * In part condition, outlet temperature data is recorded by a full average complete cycle's data.							
3.Calculation/conclusion for SCOP(Average):							
Tdesignh(°C)	-10	Tbiv(°C)		-7			
Pdesignh(kW)	7.384	TOL(°C)		-10			
Test result A, B, C, D, E, F conditions:							
Condition	Part load	Measured capacity	COP at measured capacity	Cdh	CR	COP at part load	
E	7.384	6.336	2.04	0.00	1.00	2.04	
F	6.532	6.532	2.18	0.00	1.00	2.18	
A	6.532	6.532	2.18	0.00	1.00	2.18	
B	3.976	4.007	3.29	0.00	0.99	3.29	
C	2.556	4.313	4.48	0.99	0.59	4.45	
D	1.136	4.932	6.52	0.99	0.23	6.31	
CR: part load divided by capacity;							

Doc No.: ITC-TTW0902.02E – Rev.11

Appendix I Test results

Electric power consumptions	Unit	Value
Thermostat-off mode [P_{TO}]	kW	0.017
Standby mode [P_{SB}]	kW	0.017
Crankcase heater [P_{CK}]	kW	0.029
Off mode [P_{OFF}]	kW	0.017

Conclusions:	Unit	Value
SCOPon:	kWh/kWh	3.45
SCOP:	kWh/kWh	3.44
Q_H :	kWh/year	15255
Q_{HE} :	kWh/year	4432
$\eta_{s,h}$	%	134.7
Seasonal space heating energy efficiency classes: (According (EU) No 811/2013 Table 1)	--	A++

Appendix I Test results

Table 3.	Heating mode(Low temperature application):						P
Model	CGK-030V3L-B						
Product type	Air to Water	Heating season	<input checked="" type="checkbox"/> Average	<input type="checkbox"/> Warmer	<input type="checkbox"/> Colder		
1. Test conditions:							
Condition	Part Load Ratio in %				Outdoor heat exchanger	Indoor heat exchanger	
	Formula	A	W		Inlet dry (wet) bulb temperature °C	Inlet/outlet water temperatures (°C)	
A	$(-7-16)/(T_{designh-16})$	88	N/A	N/A	-7(-8)	a / 34	
B	$(+2-16)/(T_{designh-16})$	54	N/A	N/A	2(1)	a / 30	
C	$(+7-16)/(T_{designh-16})$	35	N/A	N/A	7(6)	a / 27	
D	$(+12-16)/(T_{designh-16})$	15	N/A	N/A	12(11)	a / 24	
E	$(TOL-16)/(T_{designh-16})$				TOL	a / 35.3	
F	$(T_{bivalent-16})/(T_{designh-16})$				T _{biv}	a / 34	
G	$(-15-16)/(T_{designh-16})$	N/A	N/A	N/A	-15	N/A	
Remark: a) With the water flow rate as determined at the standard rating conditions given in EN14511-2 at 30/35 conditions, the capacity is 8398.34W, the power is 1855.76W, the COP is 4.53W/W.							
2. Tested data/correction data(Average):							
General test conditions/ Part-Load	Unit	A(-7)/W34 (88%)	A2/W30 (54%)	A7/W27 (35%)	A12/W24 (15%)	A(-10)/W35.3 (100%)	A(-7)/W34 (88%)
	--	A	B	C	D	E	F
Data collection period	hh: min:sec	4:00:00	2:10:00	2:10:00	2:10:00	4:00:00	4:00:00
The heat pump defrosts	--	Yes	No	No	No	Yes	Yes
Complete Cycles	--	1	0	0	0	1	1
Barometric pressure	kPa	101.02	101.02	101.02	101.02	101.02	101.02
Voltage	V	412.8	395.0	406.5	400.9	410.7	412.8
Current input of the unit	A	4.29	2.00	1.58	1.38	4.26	4.29
Power input of the unit	kW	2.455	0.977	0.762	0.595	2.508	2.455
Test conditions indoor unit							
Inlet Water temperature, DB	°C	29.01	27.52	34.35	20.84	30.56	29.01
Outlet Water temperature, DB	°C	33.10*	30.14	27.07	23.93	34.33*	33.10*

Doc No.: ITC-TTW0902.02E – Rev.11

Appendix I Test results

Test conditions outdoor unit							
Air inlet temperature, DB	°C	-6.96	2.04	7.01	12.01	-9.97	-6.96
Air inlet temperature, WB	°C	-8.12	1.01	6.00	11.00	-10.97	-8.12
Summary of the results							
Total heating capacity	kW	7.106	4.513	4.828	5.463	6.547	7.106
Effective power input	kW	2.488	1.010	0.795	0.628	2.541	2.488
Coefficient of performance (COP)	--	2.86	4.47	6.08	8.70	2.58	2.86
Compressor frequency	Hz	78	33	30	30	78	78
Water flow	m³/h	1.49	1.49	1.49	1.49	1.49	1.49
Remark: * In part condition, outlet temperature data is recorded by a full average complete cycle's data.							
3.Calculation/conclusion for SCOP(Average):							
Tdesignh(°C)	-10	Tbiv(°C)		-7			
Pdesignh(kW)	8.032	TOL(°C)		-10			
Test result A, B, C, D, E, F conditions:							
Condition	Part load	Measured capacity	COP at measured capacity	Cdh	CR	COP at part load	
E	8.032	6.547	2.58	0.00	1.00	2.58	
F	7.106	7.106	2.86	0.00	1.00	2.86	
A	7.106	7.106	2.86	0.00	1.00	2.86	
B	4.325	4.513	4.47	0.00	0.96	4.47	
C	2.780	4.828	6.08	0.99	0.58	6.03	
D	1.236	5.463	8.70	0.99	0.23	8.41	
CR: part load divided by capacity;							

Doc No.: ITC-TTW0902.02E – Rev.11

Appendix I Test results

Electric power consumptions	Unit	Value
Thermostat-off mode [P_{TO}]	kW	0.008
Standby mode [P_{SB}]	kW	0.008
Crankcase heater [P_{CK}]	kW	0.044
Off mode [P_{OFF}]	kW	0.008

Conclusions:	Unit	Value
SCOPon:	kWh/kWh	4.62
SCOP:	kWh/kWh	4.61
Q_H :	kWh/year	16595
Q_{HE} :	kWh/year	3601
$\eta_{s,h}$	%	181.4
Seasonal space heating energy efficiency classes: (According (EU) No 811/2013 Table 2)	--	A+++

Appendix I Test results

Table 4.	Heating mode(Medium temperature application):						P
Model	CGK-030V3L-B						
Product type	Air to Water	Heating season	<input checked="" type="checkbox"/> Average	<input type="checkbox"/> Warmer	<input type="checkbox"/> Colder		
1. Test conditions:							
Condition	Part Load Ratio in %				Outdoor heat exchanger	Indoor heat exchanger	
	Formula	A	W	C	Inlet dry (wet) bulb temperature °C	Inlet/outlet water temperatures (°C)	
A	$(-7-16)/(T_{designh-16})$	88	N/A	N/A	-7(-8)	a / 52	
B	$(+2-16)/(T_{designh-16})$	54	N/A	N/A	2(1)	a / 42	
C	$(+7-16)/(T_{designh-16})$	35	N/A	N/A	7(6)	a / 36	
D	$(+12-16)/(T_{designh-16})$	15	N/A	N/A	12(11)	a / 30	
E	$(TOL-16)/(T_{designh-16})$				TOL	a / 55.3	
F	$(T_{bivalent-16})/(T_{designh-16})$				Tbiv	a / 52	
G	$(-15-16)/(T_{designh-16})$	N/A	N/A	N/A	-15	N/A	
Remark: a) With the water flow rate as determined at the standard rating conditions given in EN14511-2 at 47/55 conditions, the capacity is 8448.64W, the power is 2926.81W, the COP is 2.89W/W.							
2. Tested data/correction data(Average):							
General test conditions/ Part-Load	Unit	A(-7)/W52 (88%)	A2/W42 (54%)	A7/W36 (35%)	A12/W30 (15%)	A(-10)/W55.3 (100%)	A(-7)/W52 (88%)
	--	A	B	C	D	E	F
Data collection period	hh: min:sec	4:00:00	2:10:00	2:10:00	2:10:00	4:00:00	4:00:00
The heat pump defrosts	--	Yes	No	No	No	Yes	Yes
Complete Cycles	--	1	0	0	0	1	1
Barometric pressure	kPa	101.02	101.02	101.02	101.02	101.02	101.02
Voltage	V	408.5	393.9	391.3	391.0	392.3	408.5
Current input of the unit	A	5.47	2.53	2.11	1.71	6.03	5.47
Power input of the unit	kW	3.226	1.258	0.979	0.755	3.593	3.226
Test conditions indoor unit							
Inlet Water temperature, DB	°C	44.20	37.96	31.51	24.91	47.04	44.20
Outlet Water temperature, DB	°C	51.27*	42.03	35.94	30.04	54.00*	51.27*

Doc No.: ITC-TTW0902.02E – Rev.11

Appendix I Test results

Test conditions outdoor unit							
Air inlet temperature, DB	°C	-6.98	2.02	7.03	12.01	-9.99	-6.98
Air inlet temperature, WB	°C	-8.20	1.00	6.00	11.00	-11.02	-8.20
Summary of the results							
Total heating capacity	kW	7.258	4.244	4.622	5.360	7.229	7.258
Effective power input	kW	3.246	1.278	0.999	0.775	3.613	3.246
Coefficient of performance (COP)	--	2.24	3.32	4.63	6.92	2.00	2.24
Compressor frequency	Hz	71	33	30	30	78	71
Water flow	m³/h	0.90	0.90	0.90	0.90	0.90	0.90
Remark: * In part condition, outlet temperature data is recorded by a full average complete cycle's data.							
3.Calculation/conclusion for SCOP(Average):							
Tdesignh(°C)	-10	Tbiv(°C)		-7			
Pdesignh(kW)	8.205	TOL(°C)		-10			
Test result A, B, C, D, E, F conditions:							
Condition	Part load	Measured capacity	COP at measured capacity	Cdh	CR	COP at part load	
E	8.205	7.229	2.00	0.00	1.00	2.00	
F	7.258	7.258	2.24	0.00	1.00	2.24	
A	7.258	7.258	2.24	0.00	1.00	2.24	
B	4.418	4.244	3.32	0.00	1.00	3.32	
C	2.840	4.622	4.63	0.99	0.61	4.60	
D	1.262	5.360	6.92	0.99	0.24	6.70	
CR: part load divided by capacity;							

Doc No.: ITC-TTW0902.02E – Rev.11

Appendix I Test results

Electric power consumptions	Unit	Value
Thermostat-off mode [P_{TO}]	kW	0.008
Standby mode [P_{SB}]	kW	0.008
Crankcase heater [P_{CK}]	kW	0.044
Off mode [P_{OFF}]	kW	0.008

Conclusions:	Unit	Value
SCOPon:	kWh/kWh	3.43
SCOP:	kWh/kWh	3.42
Q_H :	kWh/year	16951
Q_{HE} :	kWh/year	4951
$\eta_{s,h}$	%	133.9
Seasonal space heating energy efficiency classes: (According (EU) No 811/2013 Table 1)	--	A++

Appendix I Test results

Table 5.	Heating mode(Low temperature application):						P
Model	CGK-040V3L						
Product type	Air to Water	Heating season	<input checked="" type="checkbox"/> Average	<input type="checkbox"/> Warmer	<input type="checkbox"/> Colder		
1. Test conditions:							
Condition	Part Load Ratio in %				Outdoor heat exchanger	Indoor heat exchanger	
	Formula	A	W		Inlet dry (wet) bulb temperature °C	Inlet/outlet water temperatures (°C)	
A	$(-7-16)/(T_{designh-16})$	88	N/A	N/A	-7(-8)	a / 34	
B	$(+2-16)/(T_{designh-16})$	54	N/A	N/A	2(1)	a / 30	
C	$(+7-16)/(T_{designh-16})$	35	N/A	N/A	7(6)	a / 27	
D	$(+12-16)/(T_{designh-16})$	15	N/A	N/A	12(11)	a / 24	
E	$(TOL-16)/(T_{designh-16})$				TOL	a / 35.3	
F	$(T_{bivalent-16})/(T_{designh-16})$				T _{biv}	a / 34	
G	$(-15-16)/(T_{designh-16})$	N/A	N/A	N/A	-15	N/A	
Remark: a) With the water flow rate as determined at the standard rating conditions given in EN14511-2 at 30/35 conditions, the capacity is 12407.12W, the power is 2668.02W, the COP is 4.65W/W.							
2. Tested data/correction data(Average):							
General test conditions/ Part-Load	Unit	A(-7)/W34 (88%)	A2/W30 (54%)	A7/W27 (35%)	A12/W24 (15%)	A(-10)/W35.3 (100%)	A(-7)/W34 (88%)
	--	A	B	C	D	E	F
Data collection period	hh: min:sec	4:00:00	2:10:00	2:10:00	2:10:00	4:00:00	4:00:00
The heat pump defrosts	--	Yes	No	No	No	Yes	Yes
Complete Cycles	--	2	0	0	0	2	2
Barometric pressure	kPa	101.02	101.02	101.02	101.02	101.02	101.02
Voltage	V	405.7	397.1	397.0	399.1	400.3	405.7
Current input of the unit	A	6.88	3.46	3.18	2.76	7.28	6.88
Power input of the unit	kW	3.171	1.298	1.110	0.912	3.374	3.171
Test conditions indoor unit							
Inlet Water temperature, DB	°C	29.33	27.48	24.06	20.88	30.78	29.33
Outlet Water temperature, DB	°C	33.10	29.90	26.84	24.05	34.54	33.10

Doc No.: ITC-TTW0902.02E – Rev.11

Appendix I Test results

Test conditions outdoor unit							
Air inlet temperature, DB	°C	-7.00	2.01	7.01	12.00	-9.99	-7.00
Air inlet temperature, WB	°C	-8.20	1.01	6.01	11.00	-11.13	-8.20
Summary of the results							
Total heating capacity	kW	9.307	6.004	6.890	7.848	9.284	9.307
Effective power input	kW	3.219	1.346	1.158	0.960	3.422	3.219
Coefficient of performance (COP)	--	2.89	4.46	5.95	8.18	2.71	2.89
Compressor frequency	Hz	57	25	25	25	60	57
Water flow	m³/h	2.13	2.13	2.13	2.13	2.13	2.13

Remark: * In part condition, outlet temperature data is recorded by a full average complete cycle's data.

3.Calculation/conclusion for SCOP(Average):

Tdesignh(°C)	-10	Tbiv(°C)	-7
Pdesignh(kW)	10.521	TOL(°C)	-10

Test result A, B, C, D, E, F conditions:

Condition	Part load	Measured capacity	COP at measured capacity	Cdh	CR	COP at part load
E	10.521	9.284	2.71	0.00	1.00	2.71
F	9.307	9.307	2.89	0.00	1.00	2.89
A	9.307	9.307	2.89	0.00	1.00	2.89
B	5.665	6.004	4.46	0.00	0.94	4.46
C	3.642	6.890	5.95	0.99	0.53	5.90
D	1.619	7.848	8.18	0.99	0.21	7.88

CR: part load divided by capacity;

Doc No.: ITC-TTW0902.02E – Rev.11

Appendix I Test results

Electric power consumptions	Unit	Value
Thermostat-off mode [P_{TO}]	kW	0.018
Standby mode [P_{SB}]	kW	0.018
Crankcase heater [P_{CK}]	kW	0.041
Off mode [P_{OFF}]	kW	0.018

Conclusions:	Unit	Value
SCOPon:	kWh/kWh	4.60
SCOP:	kWh/kWh	4.59
Q_H :	kWh/year	21736
Q_{HE} :	kWh/year	4737
$\eta_{s,h}$	%	180.5
Seasonal space heating energy efficiency classes: (According (EU) No 811/2013 Table 2)	--	A+++

Appendix I Test results

Table 6.	Heating mode(Medium temperature application):						P
Model	CGK-040V3L						
Product type	Air to Water	Heating season	<input checked="" type="checkbox"/> Average	<input type="checkbox"/> Warmer	<input type="checkbox"/> Colder		
1. Test conditions:							
Condition	Part Load Ratio in %				Outdoor heat exchanger	Indoor heat exchanger	
	Formula	A	W	C	Inlet dry (wet) bulb temperature °C	Inlet/outlet water temperatures (°C)	
A	$(-7-16)/(T_{designh-16})$	88	N/A	N/A	-7(-8)	a / 52	
B	$(+2-16)/(T_{designh-16})$	54	N/A	N/A	2(1)	a / 42	
C	$(+7-16)/(T_{designh-16})$	35	N/A	N/A	7(6)	a / 36	
D	$(+12-16)/(T_{designh-16})$	15	N/A	N/A	12(11)	a / 30	
E	$(TOL-16)/(T_{designh-16})$				TOL	a / 55.3	
F	$(T_{bivalent-16})/(T_{designh-16})$				Tbiv	a / 52	
G	$(-15-16)/(T_{designh-16})$	N/A	N/A	N/A	-15	N/A	
Remark: a) With the water flow rate as determined at the standard rating conditions given in EN14511-2 at 47/55 conditions, the capacity is 12600.64W, the power is 4177.76W, the COP is 3.02W/W.							
2. Tested data/correction data(Average):							
General test conditions/ Part-Load	Unit	A(-7)/W52 (88%)	A2/W42 (54%)	A7/W36 (35%)	A12/W30 (15%)	A(-10)/ W55.3 (100%)	A(-7)/ W52 (88%)
	--	A	B	C	D	E	F
Data collection period	hh: min:sec	4:00:00	2:10:00	2:10:00	2:10:00	4:00:00	4:00:00
The heat pump defrosts	--	Yes	No	No	No	Yes	Yes
Complete Cycles	--	1	0	0	0	2	1
Barometric pressure	kPa	101.02	101.02	101.02	101.02	101.02	101.02
Voltage	V	400.7	404.4	400.3	395.0	401.6	400.7
Current input of the unit	A	9.07	4.16	3.65	3.04	10.50	9.07
Power input of the unit	kW	4.559	1.664	1.395	1.118	4.807	4.559
Test conditions indoor unit							
Inlet Water temperature, DB	°C	45.38	38.41	31.84	25.01	47.72	45.38
Outlet Water temperature, DB	°C	51.21	42.01	36.06	30.05	54.04*	51.21

Doc No.: ITC-TTW0902.02E – Rev.11

Appendix I Test results

Test conditions outdoor unit							
Air inlet temperature, DB	°C	-6.97	2.02	7.02	12.00	-9.86	-6.97
Air inlet temperature, WB	°C	-8.20	1.00	6.00	11.00	-11.11	-8.20
Summary of the results							
Total heating capacity	kW	9.264	5.652	6.652	7.648	9.862	9.264
Effective power input	kW	4.592	1.697	1.428	1.151	4.840	4.592
Coefficient of performance (COP)	--	2.02	3.33	4.66	6.65	2.04	2.02
Compressor frequency	Hz	52	25	25	25	60	52
Water flow	m³/h	1.36	1.36	1.36	1.36	1.36	1.36
Remark: * In part condition, outlet temperature data is recorded by a full average complete cycle's data.							
3.Calculation/conclusion for SCOP(Average):							
Tdesignh(°C)	-10	Tbiv(°C)		-7			
Pdesignh(kW)	10.472	TOL(°C)		-10			
Test result A, B, C, D, E, F conditions:							
Condition	Part load	Measured capacity	COP at measured capacity	Cdh	CR	COP at part load	
E	10.472	9.862	2.04	0.00	1.00	2.04	
F	9.264	9.264	2.02	0.00	1.00	2.02	
A	9.264	9.264	2.02	0.00	1.00	2.02	
B	5.639	5.652	3.33	0.00	1.00	3.33	
C	3.625	6.652	4.66	0.99	0.54	4.62	
D	1.611	7.648	6.65	0.99	0.21	6.41	
CR: part load divided by capacity;							

Doc No.: ITC-TTW0902.02E – Rev.11

Appendix I Test results

Electric power consumptions	Unit	Value
Thermostat-off mode [P_{TO}]	kW	0.018
Standby mode [P_{SB}]	kW	0.018
Crankcase heater [P_{CK}]	kW	0.041
Off mode [P_{OFF}]	kW	0.018

Conclusions:	Unit	Value
SCOPon:	kWh/kWh	3.46
SCOP:	kWh/kWh	3.45
Q_H :	kWh/year	21636
Q_{HE} :	kWh/year	6264
$\eta_{s,h}$	%	135.2
Seasonal space heating energy efficiency classes: (According (EU) No 811/2013 Table 1)	--	A++

Appendix I Test results

Table 7.	Heating mode(Low temperature application):						P	
Model	CGK-050V3L-B							
Product type	Air to Water	Heating season	<input checked="" type="checkbox"/>	Average	<input type="checkbox"/>	Warmer	<input type="checkbox"/>	Colder
1. Test conditions:								
Condition	Part Load Ratio in %				Outdoor heat exchanger	Indoor heat exchanger		
	Formula	A	W		Inlet dry (wet) bulb temperature °C	Inlet/outlet water temperatures (°C)		
A	$(-7-16)/(T_{designh-16})$	88	N/A	N/A	-7(-8)	a / 34		
B	$(+2-16)/(T_{designh-16})$	54	N/A	N/A	2(1)	a / 30		
C	$(+7-16)/(T_{designh-16})$	35	N/A	N/A	7(6)	a / 27		
D	$(+12-16)/(T_{designh-16})$	15	N/A	N/A	12(11)	a / 24		
E	$(TOL-16)/(T_{designh-16})$				TOL	a / 35.3		
F	$(T_{bivalent-16})/(T_{designh-16})$				Tbiv	a / 34		
G	$(-15-16)/(T_{designh-16})$	N/A	N/A	N/A	-15	N/A		
Remark: a) With the water flow rate as determined at the standard rating conditions given in EN14511-2 at 30/35 conditions, the capacity is 15607.70W, the power is 3278.59W, the COP is 4.76W/W.								
2. Tested data/correction data(Average):								
General test conditions/ Part-Load	Unit	A(-7)/W34 (88%)	A2/W30 (54%)	A7/W27 (35%)	A12/W24 (15%)	A(-10)/W35.3 (100%)	A(-7)/W34 (88%)	
	--	A	B	C	D	E	F	
Data collection period	hh: min:sec	4:00:00	2:10:00	2:10:00	2:10:00	4:00:00	4:00:00	
The heat pump defrosts	--	Yes	No	No	No	Yes	Yes	
Complete Cycles	--	1	0	0	0	1	1	
Barometric pressure	kPa	101.02	101.02	101.02	101.02	101.02	101.02	
Voltage	V	398.5	400.2	408.1	404.7	398.6	398.5	
Current input of the unit	A	6.29	2.86	2.42	2.06	6.82	6.29	
Power input of the unit	kW	3.670	1.496	1.278	1.033	3.916	3.670	
Test conditions indoor unit								
Inlet Water temperature, DB	°C	29.40	27.59	24.25	20.84	31.00	29.40	
Outlet Water temperature, DB	°C	33.28*	30.02	27.05	24.04	34.80*	33.28*	

Doc No.: ITC-TTW0902.02E – Rev.11

Appendix I Test results

Test conditions outdoor unit							
Air inlet temperature, DB	°C	-6.87	2.01	7.09	12.01	-9.97	-6.87
Air inlet temperature, WB	°C	-8.09	1.00	6.00	11.00	-11.09	-8.09
Summary of the results							
Total heating capacity	kW	11.841	7.394	8.493	9.724	11.578	11.841
Effective power input	kW	3.767	1.593	1.375	1.130	4.013	3.767
Coefficient of performance (COP)	--	3.14	4.64	6.18	8.60	2.88	3.14
Compressor frequency	Hz	67	30	30	30	70	67
Water flow	m³/h	2.62	2.62	2.62	2.62	2.62	2.62
Remark: * In part condition, outlet temperature data is recorded by a full average complete cycle's data.							
3.Calculation/conclusion for SCOP(Average):							
Tdesignh(°C)	-10	Tbiv(°C)		-7			
Pdesignh(kW)	13.386	TOL(°C)		-10			
Test result A, B, C, D, E, F conditions:							
Condition	Part load	Measured capacity	COP at measured capacity	Cdh	CR	COP at part load	
E	13.386	11.578	2.88	0.00	1.00	2.88	
F	11.841	11.841	3.14	0.00	1.00	3.14	
A	11.841	11.841	3.14	0.00	1.00	3.14	
B	7.208	7.394	4.64	0.00	0.97	4.64	
C	4.634	8.493	6.18	0.99	0.55	6.13	
D	2.059	9.724	8.60	0.99	0.21	8.30	
CR: part load divided by capacity;							

Doc No.: ITC-TTW0902.02E – Rev.11

Appendix I Test results

Electric power consumptions	Unit	Value
Thermostat-off mode [P_{TO}]	kW	0.014
Standby mode [P_{SB}]	kW	0.014
Crankcase heater [P_{CK}]	kW	0.032
Off mode [P_{OFF}]	kW	0.014

Conclusions:	Unit	Value
SCOPon:	kWh/kWh	4.82
SCOP:	kWh/kWh	4.81
Q_H :	kWh/year	27655
Q_{HE} :	kWh/year	5745
$\eta_{s,h}$	%	189.6
Seasonal space heating energy efficiency classes: (According (EU) No 811/2013 Table 2)	--	A+++

Appendix I Test results

Table 8.	Heating mode(Medium temperature application):						P
Model	CGK-050V3L-B						
Product type	Air to Water	Heating season	<input checked="" type="checkbox"/> Average	<input type="checkbox"/> Warmer	<input type="checkbox"/> Colder		
1. Test conditions:							
Condition	Part Load Ratio in %				Outdoor heat exchanger	Indoor heat exchanger	
	Formula	A	W	C	Inlet dry (wet) bulb temperature °C	Inlet/outlet water temperatures (°C)	
A	$(-7-16)/(T_{designh-16})$	88	N/A	N/A	-7(-8)	a / 52	
B	$(+2-16)/(T_{designh-16})$	54	N/A	N/A	2(1)	a / 42	
C	$(+7-16)/(T_{designh-16})$	35	N/A	N/A	7(6)	a / 36	
D	$(+12-16)/(T_{designh-16})$	15	N/A	N/A	12(11)	a / 30	
E	$(TOL-16)/(T_{designh-16})$				TOL	a / 55.3	
F	$(T_{bivalent-16})/(T_{designh-16})$				Tbiv	a / 52	
G	$(-15-16)/(T_{designh-16})$	N/A	N/A	N/A	-15	N/A	
Remark: a) With the water flow rate as determined at the standard rating conditions given in EN14511-2 at 47/55 conditions, the capacity is 15616.57W, the power is 5018.00W, the COP is 3.11W/W.							
2. Tested data/correction data(Average):							
General test conditions/ Part-Load	Unit	A(-7)/W52 (88%)	A2/W42 (54%)	A7/W36 (35%)	A12/W30 (15%)	A(-10)/ W55.3 (100%)	A(-7)/ W52 (88%)
	--	A	B	C	D	E	F
Data collection period	hh: min:sec	4:00:00	2:10:00	2:10:00	2:10:00	4:00:00	4:00:00
The heat pump defrosts	--	Yes	No	No	No	Yes	Yes
Complete Cycles	--	1	0	0	0	1	1
Barometric pressure	kPa	101.02	101.02	101.02	101.02	101.02	101.02
Voltage	V	398.2	407.6	409.0	405.4	391.3	398.2
Current input of the unit	A	8.02	3.54	3.06	2.52	9.27	8.02
Power input of the unit	kW	4.763	2.038	1.622	1.278	5.567	4.763
Test conditions indoor unit							
Inlet Water temperature, DB	°C	45.28	38.52	31.98	25.32	48.09	45.28
Outlet Water temperature, DB	°C	51.15*	42.03	36.09	30.03	54.12*	51.15*

Doc No.: ITC-TTW0902.02E – Rev.11

Appendix I Test results

Test conditions outdoor unit							
Air inlet temperature, DB	°C	-6.98	2.19	7.00	12.00	-9.86	-6.98
Air inlet temperature, WB	°C	-8.18	1.01	6.00	11.00	-11.07	-8.18
Summary of the results							
Total heating capacity	kW	11.423	6.996	8.143	9.436	11.795	11.423
Effective power input	kW	4.877	2.152	1.736	1.392	5.681	4.877
Coefficient of performance (COP)	--	2.34	3.25	4.69	6.78	2.08	2.34
Compressor frequency	Hz	63	30	30	30	70	63
Water flow	m³/h	1.70	1.70	1.70	1.70	1.70	1.70
Remark: * In part condition, outlet temperature data is recorded by a full average complete cycle's data.							
3.Calculation/conclusion for SCOP(Average):							
Tdesignh(°C)	-10	Tbiv(°C)		-7			
Pdesignh(kW)	12.913	TOL(°C)		-10			
Test result A, B, C, D, E, F conditions:							
Condition	Part load	Measured capacity	COP at measured capacity	Cdh	CR	COP at part load	
E	12.913	11.795	2.08	0.00	1.00	2.08	
F	11.423	11.423	2.34	0.00	1.00	2.34	
A	11.423	11.423	2.34	0.00	1.00	2.34	
B	6.953	6.996	3.25	0.00	0.99	3.25	
C	4.470	8.143	4.69	0.99	0.55	4.65	
D	1.987	9.436	6.78	0.99	0.21	6.53	
CR: part load divided by capacity;							

Doc No.: ITC-TTW0902.02E – Rev.11

Appendix I Test results

Electric power consumptions	Unit	Value
Thermostat-off mode [P_{TO}]	kW	0.014
Standby mode [P_{SB}]	kW	0.014
Crankcase heater [P_{CK}]	kW	0.032
Off mode [P_{OFF}]	kW	0.014

Conclusions:	Unit	Value
SCOPon:	kWh/kWh	3.52
SCOP:	kWh/kWh	3.51
Q_H :	kWh/year	26677
Q_{HE} :	kWh/year	7591
$\eta_{s,h}$	%	137.6
Seasonal space heating energy efficiency classes: (According (EU) No 811/2013 Table 1)	--	A++

Appendix I Test results

Table 9.		Clause 4 of EN 14511-4:2018			P
Model		CGK-025V3L			
Customer Code	Execution Date [dd-mm-yyyy]	Testing item	Standard Reference	Comment	Test Response
TEST 1	16-09-2022	STARTING TEST	EN14511-4:2018, §4.2.1.2 Table 3	The "lower" starting operating conditions declared by the manufacturer for the heating mode- i.e. T _{air} =-25.09°C, T _{out} water 14.90°C, Flow rate 0.85m ³ /h have been set and obtained. At those conditions, the machine was switched on. It started without any problem and worked for 30 minutes without showing any warning or alarm. During the test the machine operated in automode. No damage was recorded on the machine during and after the test.	Passed
TEST 2	16-09-2022	OPERATING TEST	EN14511-4:2018, § 4.2.1.2 Table 3	From the machine "lower" starting conditions - i.e. - the machine was brought to the lower operating conditions declared by the manufacturer for the heating mode- i.e. T _{air} =-24.99°C, T _{out} water 56.42°C, Flow rate 0.85m ³ /h. Once these conditions were obtained, the machine was let operate for over 1 hour in automode. During the test, no warning or alarm were showed. No damage was recorded on the machine during and after the test.	Passed
TEST 3	16-09-2022	SHUTTING OFF WATER FLOW	EN14511-4:2018, § 4.5	The water flow rate was shutted off through manual and automatic valves of the test rig. The machine switched off and only the flow switch Protection appeared on the user interface of indoor unit. Perform error reset operation , once the water flow rate was restored, the machine restarted automatically and worked for 30 minutes normally. No damage was recorded on the machine during and after the test.	Passed
TEST 4	16-09-2022	SHUTTING OFF AIR FLOW	EN14511-4:2018, § 4.5	The air flow rate was shutted off through a plastic sheet and a panel. The machine never turned off. It continued to operate with continuous frosting and defrosting cycles. After more than half an hour, the air flow rate was restored and the machine started to operate normally. During the test, no warning or alarm were showed. No damage was recorded on the machine during and after the test.	Passed
TEST 5	16-09-2022	COMPLETE POWER SUPPLY FAILURE	EN14511-4:2018, § 4.6	The power supply was cut off for about 10 seconds. The unit restarted automatically within about 3 minutes after the power supply was reactivated.	Passed

Doc No.: ITC-TTW0902.02E – Rev.1.1

Appendix I Test results

Table 10. Clause 4 of EN 14511-4:2018					P
Model	CGK-030V3L-B				
Customer Code	Execution Date [dd-mm-yyyy]	Testing item	Standard Reference	Comment	Test Response
TEST 1	17-09-2022	STARTING TEST	EN14511-4:2018, §4.2.1.2 Table 3	The "lower" starting operating conditions declared by the manufacturer for the heating mode- i.e. Tair=-25.12°C, T out water 14.70°C, Flow rate 0.80m ³ /h have been set and obtained. At those conditions, the machine was switched on. It started without any problem and worked for 30 minutes without showing any warning or alarm. During the test the machine operated in automode. No damage was recorded on the machine during and after the test.	Passed
TEST 2	17-09-2022	OPERATING TEST	EN14511-4:2018, § 4.2.1.2 Table 3	From the machine "lower" starting conditions - i.e. - the machine was brought to the lower operating conditions declared by the manufacturer for the heating mode- i.e. Tair=-25.21°C, T out water 56.25°C, Flow rate 0.82m ³ /h. Once these conditions were obtained, the machine was let operate for over 1 hour in automode. During the test, no warning or alarm were showed. No damage was recorded on the machine during and after the test.	Passed
TEST 3	17-09-2022	SHUTTING OFF WATER FLOW	EN14511-4:2018, § 4.5	The water flow rate was shutted off through manual and automatic valves of the test rig. The machine switched off and only the flow switch Protection appeared on the user interface of indoor unit. Perform error reset operation , once the water flow rate was restored, the machine restarted automatically and worked for 30 minutes normally. No damage was recorded on the machine during and after the test.	Passed
TEST 4	17-09-2022	SHUTTING OFF AIR FLOW	EN14511-4:2018, § 4.5	The air flow rate was shutted off through a plastic sheet and a panel. The machine never turned off. It continued to operate with continuous frosting and defrosting cycles. After more than half an hour, the air flow rate was restored and the machine started to operate normally. During the test, no warning or alarm were showed. No damage was recorded on the machine during and after the test.	Passed
TEST 5	17-09-2022	COMPLETE POWER SUPPLY FAILURE	EN14511-4:2018, § 4.6	The power supply was cut off for about 10 seconds. The unit restarted automatically within about 3 minutes after the power supply was reactivated.	Passed

Doc No.: ITC-TTW0902.02E – Rev.1.1

Appendix I Test results

Table 11. Clause 4 of EN 14511-4:2018					P
Model	CGK-040V3L				
Customer Code	Execution Date [dd-mm-yyyy]	Testing item	Standard Reference	Comment	Test Response
TEST 1	18-09-2022	STARTING TEST	EN14511-4:2018, §4.2.1.2 Table 3	The "lower" starting operating conditions declared by the manufacturer for the heating mode- i.e. T _{air} =-25.05°C, T _{out} water 14.77°C, Flow rate 1.23m ³ /h have been set and obtained. At those conditions, the machine was switched on. It started without any problem and worked for 30 minutes without showing any warning or alarm. During the test the machine operated in automode. No damage was recorded on the machine during and after the test.	Passed
TEST 2	18-09-2022	OPERATING TEST	EN14511-4:2018, § 4.2.1.2 Table 3	From the machine "lower" starting conditions - i.e. - the machine was brought to the lower operating conditions declared by the manufacturer for the heating mode- i.e. T _{air} =-25.01°C, T _{out} water 56.37°C, Flow rate 1.23m ³ /h. Once these conditions were obtained, the machine was let operate for over 1 hour in automode. During the test, no warning or alarm were showed. No damage was recorded on the machine during and after the test.	Passed
TEST 3	18-09-2022	SHUTTING OFF WATER FLOW	EN14511-4:2018, § 4.5	The water flow rate was shutted off through manual and automatic valves of the test rig. The machine switched off and only the flow switch Protection appeared on the user interface of indoor unit. Perform error reset operation , once the water flow rate was restored, the machine restarted automatically and worked for 30 minutes normally. No damage was recorded on the machine during and after the test.	Passed
TEST 4	18-09-2022	SHUTTING OFF AIR FLOW	EN14511-4:2018, § 4.5	The air flow rate was shutted off through a plastic sheet and a panel. The machine never turned off. It continued to operate with continuous frosting and defrosting cycles. After more than half an hour, the air flow rate was restored and the machine started to operate normally. During the test, no warning or alarm were showed. No damage was recorded on the machine during and after the test.	Passed
TEST 5	18-09-2022	COMPLETE POWER SUPPLY FAILURE	EN14511-4:2018, § 4.6	The power supply was cut off for about 10 seconds. The unit restarted automatically within about 3 minutes after the power supply was reactivated.	Passed

Doc No.: ITC-TTW0902.02E – Rev.1.1

Appendix I Test results

Table 12. Clause 4 of EN 14511-4:2018					P
Model	CGK-050V3L-B				
Customer Code	Execution Date [dd-mm-yyyy]	Testing item	Standard Reference	Comment	Test Response
TEST 1	19-09-2022	STARTING TEST	EN14511-4:2018, §4.2.1.2 Table 3	The "lower" starting operating conditions declared by the manufacturer for the heating mode- i.e. Tair=-24.92°C, T out water 14.05°C, Flow rate 1.55m ³ /h have been set and obtained. At those conditions, the machine was switched on. It started without any problem and worked for 30 minutes without showing any warning or alarm. During the test the machine operated in automode. No damage was recorded on the machine during and after the test.	Passed
TEST 2	19-09-2022	OPERATING TEST	EN14511-4:2018, §4.2.1.2 Table 3	From the machine "lower" starting conditions - i.e. - the machine was brought to the lower operating conditions declared by the manufacturer for the heating mode- i.e. Tair=-24.15°C, T out water 56.89°C, Flow rate 1.53m ³ /h. Once these conditions were obtained, the machine was let operate for over 1 hour in automode. During the test, no warning or alarm were showed. No damage was recorded on the machine during and after the test.	Passed
TEST 3	19-09-2022	SHUTTING OFF WATER FLOW	EN14511-4:2018, § 4.5	The water flow rate was shutted off through manual and automatic valves of the test rig. The machine switched off and only the flow switch Protection appeared on the user interface of indoor unit. Perform error reset operation , once the water flow rate was restored, the machine restarted automatically and worked for 30 minutes normally. No damage was recorded on the machine during and after the test.	Passed
TEST 4	19-09-2022	SHUTTING OFF AIR FLOW	EN14511-4:2018, § 4.5	The air flow rate was shutted off through a plastic sheet and a panel. The machine never turned off. It continued to operate with continuous frosting and defrosting cycles. After more than half an hour, the air flow rate was restored and the machine started to operate normally. During the test, no warning or alarm were showed. No damage was recorded on the machine during and after the test.	Passed
TEST 5	19-09-2022	COMPLETE POWER SUPPLY FAILURE	EN14511-4:2018, § 4.6	The power supply was cut off for about 10 seconds. The unit restarted automatically within about 3 minutes after the power supply was reactivated.	Passed

Doc No.: ITC-TTW0902.02E – Rev.1.1

Appendix I Test results

Table 13a.	Sound power level measurement(Low temperature application)	P	
Model	CGK-025V3L		
	Product type :	Air to Water	
	Outdoor heat exchanger, Air temperature DB/WB (°C):	7.0 /6.0	
	Indoor heat exchanger, Water inlet/outlet temperature (°C):	30.0 /35.0	
	Voltage (V):	400	
	Frequency (Hz):	50	
	Working condition class :	Class A	
	Acoustical environment :	Hemi-anechoic room	
	Windshield type :	Sponge	
	Measured position amount :	14	
	Water flow (m ³ /h):	1.35	
Measured quantity	L _{WA,indoors} (dB(A))	L _{WA,outdoors} (dB(A))	Remark
Sound pressure level $\bar{L}_{p(ST)}$ ****	--	44	--
Spheres radius d *	--	1.0m	--
Sound power level L _{WA} ****	--	58	--
Setting of controls: according to user manual. Duct connection:-- Rounding to: *) 1 decimal places; **) 2 decimal places; ***) 3 decimal places; ****) nearest integer Fan speed: 450 r/min, compressor speed: 55Hz.			

Appendix I Test results

Table 13b.	Sound power level measurement(Medium temperature application)	P	
Model	CGK-025V3L		
	Product type :	Air to Water	
	Outdoor heat exchanger, Air temperature DB/WB (°C):	7.0 /6.0	
	Indoor heat exchanger, Water inlet/outlet temperature (°C):	47.0 /55.0	
	Voltage (V):	400	
	Frequency (Hz):	50	
	Working condition class :	Class A	
	Acoustical environment :	Hemi-anechoic room	
	Windshield type :	Sponge	
	Measured position amount :	14	
	Water flow (m ³ /h):	0.87	
Measured quantity	L _{WA,indoors} (dB(A))	L _{WA,outdoors} (dB(A))	Remark
Sound pressure level $\bar{L}_{p(ST)}$ ****	--	47	--
Spheres radius d *	--	1.0m	--
Sound power level L _{WA} ****	--	61	--
Setting of controls: according to user manual. Duct connection:-- Rounding to: *) 1 decimal places; **) 2 decimal places; ***) 3 decimal places; ****) nearest integer Fan speed: 460 r/min, compressor speed: 55Hz.			

Appendix I Test results

Table 14a.	Sound power level measurement(Low temperature application)	P	
Model	CGK-030V3L-B		
	Product type :	Air to Water	
	Outdoor heat exchanger, Air temperature DB/WB (°C):	7.0 /6.0	
	Indoor heat exchanger, Water inlet/outlet temperature (°C):	30.0 /35.0	
	Voltage (V):	400	
	Frequency (Hz):	50	
	Working condition class :	Class A	
	Acoustical environment :	Hemi-anechoic room	
	Windshield type :	Sponge	
	Measured position amount :	14	
	Water flow (m ³ /h):	1.49	
Measured quantity	L _{WA,indoors} (dB(A))	L _{WA,outdoors} (dB(A))	Remark
Sound pressure level $\bar{L}_{p(ST)}$ ****	--	50	--
Spheres radius d *	--	1.0m	--
Sound power level L _{WA} ****	--	64	--
Setting of controls: according to user manual. Duct connection:-- Rounding to: *) 1 decimal places; **) 2 decimal places; ***) 3 decimal places; ****) nearest integer Fan speed: 680 r/min, compressor speed: 55Hz.			

Appendix I Test results

Table 14b.	Sound power level measurement(Medium temperature application)		P
Model	CGK-030V3L-B		
	Product type :	Air to Water	
	Outdoor heat exchanger, Air temperature DB/WB (°C):	7.0 /6.0	
	Indoor heat exchanger, Water inlet/outlet temperature (°C):	47.0 /55.0	
	Voltage (V):	400	
	Frequency (Hz):	50	
	Working condition class :	Class A	
	Acoustical environment :	Hemi-anechoic room	
	Windshield type :	Sponge	
	Measured position amount :	14	
	Water flow (m ³ /h):	0.90	
Measured quantity	L _{WA,indoors} (dB(A))	L _{WA,outdoors} (dB(A))	Remark
Sound pressure level $\bar{L}_{p(ST)}$ ****	--	50	--
Spheres radius d *	--	1.0m	--
Sound power level L _{WA} ****	--	65	--
Setting of controls: according to user manual. Duct connection:-- Rounding to: *) 1 decimal places; **) 2 decimal places; ***) 3 decimal places; ****) nearest integer Fan speed: 630 r/min, compressor speed: 55Hz.			

Appendix I Test results

Table 15a.	Sound power level measurement(Low temperature application)	P	
Model	CGK-040V3L		
	Product type :	Air to Water	
	Outdoor heat exchanger, Air temperature DB/WB (°C):	7.0 /6.0	
	Indoor heat exchanger, Water inlet/outlet temperature (°C):	30.0 /35.0	
	Voltage (V):	400	
	Frequency (Hz):	50	
	Working condition class :	Class A	
	Acoustical environment :	Hemi-anechoic room	
	Windshield type :	Sponge	
	Measured position amount :	14	
	Water flow (m ³ /h):	2.13	
Measured quantity	L _{WA,indoors} (dB(A))	L _{WA,outdoors} (dB(A))	Remark
Sound pressure level $\bar{L}_{p(ST)}$ ****	--	48	--
Spheres radius d *	--	1.0m	--
Sound power level L _{WA} ****	--	63	--
Setting of controls: according to user manual. Duct connection:-- Rounding to: *) 1 decimal places; **) 2 decimal places; ***) 3 decimal places; ****) nearest integer Fan speed: 460 r/min, compressor speed: 45Hz.			

Appendix I Test results

Table 15b.	Sound power level measurement(Medium temperature application)	P	
Model	CGK-040V3L		
	Product type :	Air to Water	
	Outdoor heat exchanger, Air temperature DB/WB (°C):	7.0 /6.0	
	Indoor heat exchanger, Water inlet/outlet temperature (°C):	47.0 /55.0	
	Voltage (V):	400	
	Frequency (Hz):	50	
	Working condition class :	Class A	
	Acoustical environment :	Hemi-anechoic room	
	Windshield type :	Sponge	
	Measured position amount :	14	
	Water flow (m ³ /h):	1.36	
Measured quantity	L _{WA,indoors} (dB(A))	L _{WA,outdoors} (dB(A))	Remark
Sound pressure level $\bar{L}_{p(ST)}$ ****	--	52	--
Spheres radius d *	--	1.0m	--
Sound power level L _{WA} ****	--	67	--
Setting of controls: according to user manual. Duct connection:-- Rounding to: *) 1 decimal places; **) 2 decimal places; ***) 3 decimal places; ****) nearest integer Fan speed: 680 r/min, compressor speed: 45Hz.			





Appendix I Test results

Table 16a.	Sound power level measurement(Low temperature application)		P
Model	CGK-050V3L-B		
	Product type :	Air to Water	
	Outdoor heat exchanger, Air temperature DB/WB (°C):	7.0 /6.0	
	Indoor heat exchanger, Water inlet/outlet temperature (°C):	30.0 /35.0	
	Voltage (V):	400	
	Frequency (Hz):	50	
	Working condition class :	Class A	
	Acoustical environment :	Hemi-anechoic room	
	Windshield type :	Sponge	
	Measured position amount :	14	
	Water flow (m ³ /h):	2.62	
	Measured quantity	L_{WA,indoors} (dB(A))	L_{WA,outdoors} (dB(A))
	Sound pressure level $\bar{L}_{p(ST)}$ ****	--	48
	Spheres radius d *	--	1.0m
	Sound power level L _{WA} ****	--	63
Setting of controls: according to user manual. Duct connection:-- Rounding to: *) 1 decimal places; **) 2 decimal places; ***) 3 decimal places; ****) nearest integer Fan speed: 560 r/min, compressor speed: 55Hz.			

Appendix I Test results

Table 16b.	Sound power level measurement(Medium temperature application)	P	
Model	CGK-050V3L-B		
	Product type :	Air to Water	
	Outdoor heat exchanger, Air temperature DB/WB (°C):	7.0 /6.0	
	Indoor heat exchanger, Water inlet/outlet temperature (°C):	47.0 /55.0	
	Voltage (V):	400	
	Frequency (Hz):	50	
	Working condition class :	Class A	
	Acoustical environment :	Hemi-anechoic room	
	Windshield type :	Sponge	
	Measured position amount :	14	
	Water flow (m ³ /h):	1.70	
Measured quantity	L _{WA,indoors} (dB(A))	L _{WA,outdoors} (dB(A))	Remark
Sound pressure level $\bar{L}_{p(ST)}$ ****	--	53	--
Spheres radius d *	--	1.0m	--
Sound power level L _{WA} ****	--	68	--
Setting of controls: according to user manual. Duct connection:-- Rounding to: *) 1 decimal places; **) 2 decimal places; ***) 3 decimal places; ****) nearest integer Fan speed: 650 r/min, compressor speed: 55Hz.			

Appendix II Marking plate





Nameplate	
Model: <u>CGK-025V3L</u>	
   	
EVI DC Inverter Air Source Heat Pumps	
Model	CGK-025V3L
Power Supply	380-420V, 3N~/50Hz
*Heating Capacity Min./Max.	4.37/9.5kW
*Heating Input Power Min./Max.	0.76/2.07kW
*Heating COP Min./Max.	4.59/5.75W/W
Cooling Capacity Min./Max.	2.85/6.2kW
Cooling Input Power Min./Max.	0.76/2.4kW
Rated. Input Power/Current	3kW/6.3A
Max. Water Outlet Temperature	55°C
Water Flow	1.6m ³ /h
Refrigerant/Weight	R32/1500g
Low/High side operation pressure	1.5/4.4MPa
Maximum allowable pressure	4.4MPa
Max Water Pressure	1.0MPa
Shock Proof Grade	I
WaterProof Level	IPX4
Water Pressure Drop	18kPa
Water Pipe Connection	1 inch
Net Weight	80kg
Date/NO.	See bar code
System CO2 equivalent charge weight: 1.01 ton	
*Heating working condition: Dry bulb temperature 7°C, Wet bulb temperature 6°C, Inlet water temperature 30°C, Outlet water temperature 35°C.	
Guangzhou Sprsun New Energy Technology Development Co., Ltd No. 15 Tangxi Road, Yinsha Industrial Park, Xintang, Zengcheng, Guangzhou, China	

Doc No.: ITC-TTW0902.02E – Rev.11

Appendix II Marking plate

Nameplate

Model: CGK-030V3L-B

EVI DC Inverter Air Source Heat Pumps

Model	CGK-030V3L-B
Power Supply	380-420V, 3N~/50Hz
*Heating Capacity Min./Max.	5.34/11.6kW
*Heating Input Power Min./Max.	0.97/2.62kW
*Heating COP Min./Max.	4.43/5.51W/W
Cooling Capacity Min./Max.	3.43/7.46kW
Cooling Input Power Min./Max.	0.95/3.11kW
Rated. Input Power/Current	3.94kW/8.31A
Max. Water Outlet Temperature	55°C
Water Flow	2m ³ /h
Refrigerant/Weight	R32/1700g
Low/High side operation pressure	1.5/4.4MPa
Maximum allowable pressure	4.4MPa
Max Water Pressure	1.0MPa
Shock Proof Grade	I
WaterProof Level	IPX4
Water Pressure Drop	20kPa
Water Pipe Connection	1 inch
Net Weight	88kg
Date/NO.	See bar code





System CO2 equivalent charge weight: 1.15 ton

***Heating working condition:**
Dry bulb temperature 7°C, Wet bulb temperature 6°C,
Inlet water temperature 30°C, Outlet water temperature 35°C.

Guangzhou Sprsun New Energy Technology Development Co., Ltd
No. 15 Tangxi Road, Yinsha Industrial Park, Xintang, Zengcheng,
Guangzhou, China





Doc No.: ITC-TTW0902.02E – Rev.11

Appendix II Marking plate

Nameplate	
Model: <u>CGK-040V3L</u>	
   	
EVI DC Inverter Air Source Heat Pumps	
Model	CGK-040V3L
Power Supply	380-420V, 3N~/50Hz
*Heating Capacity Min./Max.	7.36/16kW
*Heating Input Power Min./Max.	1.25/3.4kW
*Heating COP Min./Max.	4.70/5.89W/W
Cooling Capacity Min./Max.	4.8/10.44kW
Cooling Input Power Min./Max.	1.25/3.93kW
Rated. Input Power/Current	4.9kW/10.4A
Max. Water Outlet Temperature	55°C
Water Flow	2.7m ³ /h
Refrigerant/Weight	R32/2000g
Low/High side operation pressure	1.5/4.4MPa
Maximum allowable pressure	4.4MPa
Max Water Pressure	1.0MPa
Shock Proof Grade	I
WaterProof Level	IPX4
Water Pressure Drop	21kPa
Water Pipe Connection	1 inch
Net Weight	98kg
Date/NO.	See bar code
System CO2 equivalent charge weight: 1.35 ton	
*Heating working condition: Dry bulb temperature 7°C, Wet bulb temperature 6°C, Inlet water temperature 30°C, Outlet water temperature 35°C.	
Guangzhou Sprsun New Energy Technology Development Co., Ltd No. 15 Tangxi Road, Yinsha Industrial Park, Xintang, Zengcheng, Guangzhou, China	

Doc No.: ITC-TTW0902.02E – Rev.11

Appendix II Marking plate

Nameplate	
Model: <u>CGK-050V3L-B</u>	
   	
EVI DC Inverter Air Source Heat Pumps	
Model	CGK-050V3L-B
Power Supply	380-420V, 3N~/50Hz
*Heating Capacity Min./Max.	9.11/19.8kW
*Heating Input Power Min./Max.	1.54/4.2kW
*Heating COP Min./Max.	4.71/5.92W/W
Cooling Capacity Min./Max.	5.86/12.74kW
Cooling Input Power Min./Max.	1.52/4.97kW
Rated. Input Power/Current	6.29kW/13.28A
Max. Water Outlet Temperature	55°C
Water Flow	3.4m ³ /h
Refrigerant/Weight	R32/2800g
Low/High side operation pressure	1.5/4.4MPa
Maximum allowable pressure	4.4MPa
Max Water Pressure	1.0MPa
Shock Proof Grade	I
WaterProof Level	IPX4
Water Pressure Drop	23kPa
Water Pipe Connection	1 inch
Net Weight	124kg
Date/NO.	See bar code
System CO2 equivalent charge weight: 1.89 ton	
*Heating working condition: Dry bulb temperature 7°C, Wet bulb temperature 6°C, Inlet water temperature 30°C, Outlet water temperature 35°C.	
Guangzhou Sprsun New Energy Technology Development Co., Ltd No. 15 Tangxi Road, Yinsha Industrial Park, Xintang, Zengcheng, Guangzhou, China	

Doc No.: ITC-TTW0902.02E – Rev.11

Appendix III photo documentaiton

Details of:	Overall view for CGK-025V3L
View:	
<input type="checkbox"/> General	
<input type="checkbox"/> Front	
<input type="checkbox"/> Rear	
<input type="checkbox"/> Right	
<input type="checkbox"/> Left	
<input type="checkbox"/> Top	
<input type="checkbox"/> Bottom	

Details of:	Compressor for CGK-025V3L
View:	
<input type="checkbox"/> General	
<input type="checkbox"/> Front	
<input type="checkbox"/> Rear	
<input type="checkbox"/> Right	
<input type="checkbox"/> Left	
<input type="checkbox"/> Top	
<input type="checkbox"/> Bottom	

Doc No.: ITC-TTW0902.02E – Rev.11

Appendix III photo documentaiton

Details of:	Fan Motor for CGK-025V3L
<p>View:</p> <p><input type="checkbox"/> General</p> <p><input type="checkbox"/> Front</p> <p><input type="checkbox"/> Rear</p> <p><input type="checkbox"/> Right</p> <p><input type="checkbox"/> Left</p> <p><input type="checkbox"/> Top</p> <p><input type="checkbox"/> Bottom</p>	

Details of:	Main Control Board for CGK-025V3L
<p>View:</p> <p><input type="checkbox"/> General</p> <p><input type="checkbox"/> Front</p> <p><input type="checkbox"/> Rear</p> <p><input type="checkbox"/> Right</p> <p><input type="checkbox"/> Left</p> <p><input type="checkbox"/> Top</p> <p><input type="checkbox"/> Bottom</p>	

Doc No.: ITC-TTW0902.02E – Rev.11

Appendix III photo documentaiton

Details of:	Overall view for CGK-030V3L-B
View:	
<input type="checkbox"/> General	
<input type="checkbox"/> Front	
<input type="checkbox"/> Rear	
<input type="checkbox"/> Right	
<input type="checkbox"/> Left	
<input type="checkbox"/> Top	
<input type="checkbox"/> Bottom	

Details of:	Compressor for CGK-030V3L-B
View:	
<input type="checkbox"/> General	
<input type="checkbox"/> Front	
<input type="checkbox"/> Rear	
<input type="checkbox"/> Right	
<input type="checkbox"/> Left	
<input type="checkbox"/> Top	
<input type="checkbox"/> Bottom	

Doc No.: ITC-TTW0902.02E – Rev.11

Appendix III photo documentaiton

Details of:	Fan Motor for CGK-030V3L-B
View:	
<input type="checkbox"/> General	
<input type="checkbox"/> Front	
<input type="checkbox"/> Rear	
<input type="checkbox"/> Right	
<input type="checkbox"/> Left	
<input type="checkbox"/> Top	
<input type="checkbox"/> Bottom	

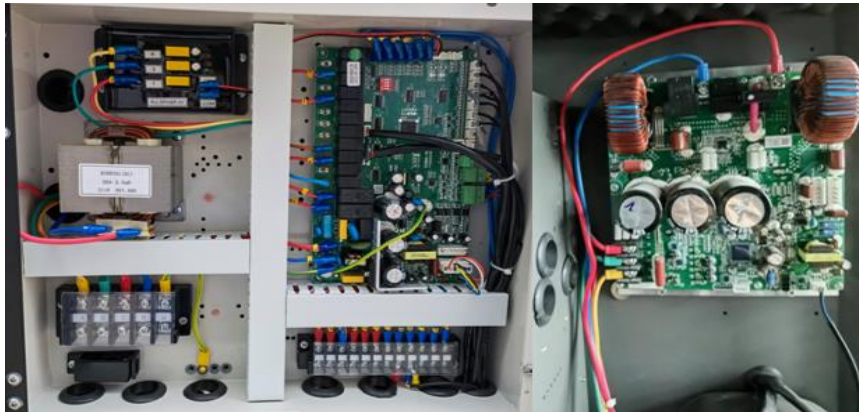
Details of:	Main Control Board for CGK-030V3L-B
View:	
<input type="checkbox"/> General	
<input type="checkbox"/> Front	
<input type="checkbox"/> Rear	
<input type="checkbox"/> Right	
<input type="checkbox"/> Left	
<input type="checkbox"/> Top	
<input type="checkbox"/> Bottom	

Doc No.: ITC-TTW0902.02E -- Rev.11

Appendix III photo documentaiton

Details of:	Overall view for CGK-040V3L
View:	
<input type="checkbox"/> General	
<input type="checkbox"/> Front	
<input type="checkbox"/> Rear	
<input type="checkbox"/> Right	
<input type="checkbox"/> Left	
<input type="checkbox"/> Top	
<input type="checkbox"/> Bottom	

Details of:	Compressor for CGK-040V3L
View:	
<input type="checkbox"/> General	
<input type="checkbox"/> Front	
<input type="checkbox"/> Rear	
<input type="checkbox"/> Right	
<input type="checkbox"/> Left	
<input type="checkbox"/> Top	
<input type="checkbox"/> Bottom	

Doc No.: ITC-TTW0902.02E – Rev.1.1

Appendix III photo documentaiton

Details of:	Fan Motor for CGK-040V3L
View:	
<input type="checkbox"/> General	
<input type="checkbox"/> Front	
<input type="checkbox"/> Rear	
<input type="checkbox"/> Right	
<input type="checkbox"/> Left	
<input type="checkbox"/> Top	
<input type="checkbox"/> Bottom	

Details of:	Main Control Board for CGK-040V3L
View:	
<input type="checkbox"/> General	
<input type="checkbox"/> Front	
<input type="checkbox"/> Rear	
<input type="checkbox"/> Right	
<input type="checkbox"/> Left	
<input type="checkbox"/> Top	
<input type="checkbox"/> Bottom	

Doc No.: ITC-TTW0902.02E – Rev.11

Appendix III photo documentaiton

Details of:	Overall view for CGK-050V3L-B
<p>View:</p> <input type="checkbox"/> General <input type="checkbox"/> Front <input type="checkbox"/> Rear <input type="checkbox"/> Right <input type="checkbox"/> Left <input type="checkbox"/> Top <input type="checkbox"/> Bottom	

Details of:	Compressor for CGK-050V3L-B
<p>View:</p> <input type="checkbox"/> General <input type="checkbox"/> Front <input type="checkbox"/> Rear <input type="checkbox"/> Right <input type="checkbox"/> Left <input type="checkbox"/> Top <input type="checkbox"/> Bottom	

Doc No.: ITC-TTW0902.02E -- Rev.11

Appendix III photo documentaiton

Details of:	Fan Motor for CGK-050V3L-B
<p>View:</p> <p><input type="checkbox"/> General</p> <p><input type="checkbox"/> Front</p> <p><input type="checkbox"/> Rear</p> <p><input type="checkbox"/> Right</p> <p><input type="checkbox"/> Left</p> <p><input type="checkbox"/> Top</p> <p><input type="checkbox"/> Bottom</p>	 <p>The photograph shows a white label for a brushless DC motor. The text on the label includes: '直流无刷电动机' (Brushless DC Motor), 'SIC-82FX-F1116-1', 'DC310V 8P 116W', '900r/min E级', 'G C 1MI15.', 'Nidec 日本电产芝浦 (浙江) 有限公司', and 'LD-004DC116-1'. A wiring diagram shows connections for Vm (red), GND (black), Vsp (yellow), Vcc (white), and PG (blue). A QR code and a rotation arrow are also present.</p>

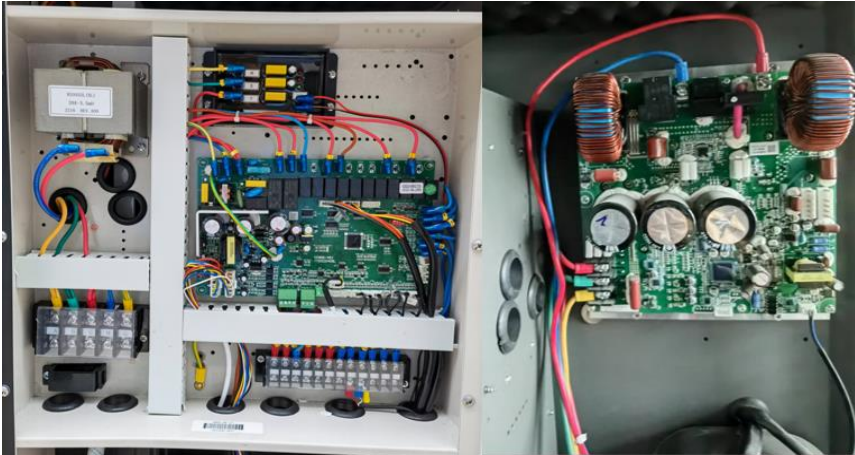
Details of:	Main Control Board for CGK-050V3L-B
<p>View:</p> <p><input type="checkbox"/> General</p> <p><input type="checkbox"/> Front</p> <p><input type="checkbox"/> Rear</p> <p><input type="checkbox"/> Right</p> <p><input type="checkbox"/> Left</p> <p><input type="checkbox"/> Top</p> <p><input type="checkbox"/> Bottom</p>	 <p>The photograph shows a green printed circuit board (PCB) populated with various electronic components, including capacitors, resistors, and integrated circuits. It is densely packed with multi-colored wires connected to terminals. The board is housed within a metal enclosure.</p>

Doc No.: ITC-TT-W0902.02E – Rev.11

Appendix IV Construction data form

Model: <u>CGK-025V3L</u>		
Part		Technical data
1. Compressor		
	Manufacture:	Panasonic Wanbao Appliances Compressor (Guangzhou) Co.,Ltd.
	Type:	9RD220ZAA2J
	Rated capacity:	2265W
	Serial-number:	F0002644
	Specification:	DC280V; R32
2. Condenser		
	Manufacture:	East -Alliance Thermal Equipment
	Type:	EATB61-D-22-2M-2L
	Heat exchanger:	Plate heat exchanger
	Dimension (mm):	539(L)mmX125(H)mmX64(D)mm
3. Evaporator		
	Manufacture:	Guangzhou Aotai Refrigeration EquipmentCo.,Ltd.
	Type:	03KA-CP-04
	Heat exchanger:	Finned-coil heat exchanger
	Dimension (mm):	660(L)mmX750(H)mmX345(D)mm
4. Fan motor		
	Manufacture:	Wolong Electric Group Co., Ltd
	Type:	ZWB278D04A
	Fan type:	3 blade
	Specification:	DC310V; 102W
5. Main control board		
	Manufacture:	CAREL
	Type:	UP3CON0S00
	Specification:	380-420V; 50Hz

Appendix IV Construction data form

Model: <u>CGK-030V3L-B</u>		
Part		Technical data
1. Compressor		
	Manufacture:	Panasonic Wanbao Appliances Compressor (Guangzhou) Co.,Ltd.
	Type:	9KD240ZAA2J
	Rated capacity:	2580W
	Serial-number:	F0003015
	Specification:	DC280V; R32
2. Condenser		
	Manufacture:	Jiangsu Yuanzhuo Equipment Manufactur Co.,Ltd
	Type:	ZL62FA-26AD-CG
	Heat exchanger:	Plate heat exchanger
	Dimension (mm):	526(L)mmX119(H)mmX63(D)mm
3. Evaporator		
	Manufacture:	Guangzhou Aotai Refrigeration EquipmentCo.,Ltd.
	Type:	03KA-CP-01
	Heat exchanger:	Finned-coil heat exchanger
	Dimension (mm):	660(L)mmX750(H)mmX345(D)mm
4. Fan motor		
	Manufacture:	Nidec Shibaura (Zhejiang) Co., Ltd.
	Type:	SIC-82FX-F1116-1
	Fan type:	3 blade
	Specification:	DC310V; 116W
5. Main control board		
	Manufacture:	CHICO
	Type:	CG248075
	Specification:	380-420V; 50Hz

Doc No.: ITC-TTW0902.02E – Rev.11

Appendix IV Construction data form

Model: <u>CGK-040V3L</u>		
Part		Technical data
1. Compressor		
	Manufacture:	Panasonic Wanbao Appliances Compressor (Guangzhou) Co.,Ltd.
	Type:	9VD420ZAA2J
	Rated capacity:	4390W
	Serial-number:	F0006867
	Specification:	DC280V; R32
2. Condenser		
	Manufacture:	East -Alliance Thermal Equipment
	Type:	EATB61-D-30-2M-2L
	Heat exchanger:	Plate heat exchanger
	Dimension (mm):	542(L)mmX126(H)mmX83(D)mm
3. Evaporator		
	Manufacture:	Guangzhou Aotai Refrigeration EquipmentCo.,Ltd.
	Type:	04KA-CP-01
	Heat exchanger:	Finned-coil heat exchanger
	Dimension (mm):	660(L)mmX910(H)mmX345(D)mm
4. Fan motor		
	Manufacture:	Wolong Electric Group Co., Ltd
	Type:	ZWB378D98A
	Fan type:	3 blade
	Specification:	DC310V; 150W
5. Main control board		
	Manufacture:	CAREL
	Type:	UP3CON0S00
	Specification:	380-420V; 50Hz

Appendix IV Construction data form

Model: <u>CGK-050V3L-B</u>		
Part		Technical data
1. Compressor		
	Manufacture:	Panasonic Wanbao Appliances Compressor (Guangzhou) Co.,Ltd.
	Type:	9VD420ZAA2J
	Rated capacity:	4390W
	Serial-number:	F0004942
	Specification:	DC280V; R32
2. Condenser		
	Manufacture:	Jiangsu Yuanzhuo Equipment Manufactur Co.,Ltd
	Type:	ZL62FA-40AD-CG
	Heat exchanger:	Plate heat exchanger
	Dimension (mm):	526(L)mmX119(H)mmX91(D)mm
3. Evaporator		
	Manufacture:	Guangzhou Aotai Refrigeration EquipmentCo.,Ltd.
	Type:	05KA-CP-01
	Heat exchanger:	Finned-coil heat exchanger
	Dimension (mm):	660(L)mmX1300(H)mmX345(D)mm
4. Fan motor		
	Manufacture:	Nidec Shibaura (Zhejiang) Co., Ltd.
	Type:	SIC-82FX-F1116-1
	Fan type:	3 blade
	Specification:	DC310V; 116W
5. Main control board		
	Manufacture:	CHICO
	Type:	CG248075
	Specification:	380-420V; 50Hz

Appendix V Equipment List

No.	Type	Manufacture	Model	Equipment ID	Calibration Due Date
1	Digital power meter	YOKOGAWA	WT230	91HC39024	2023-01-04
2	Platinum resistance	CHINO	Pt100	TS-019XC0130	2023-01-04
3	Platinum resistance	CHINO	Pt100	TS3XA0248	2023-01-04
4	Temperature and humidity sensor	YOKOGAWA	HMD62	S4610294	2023-01-04
5	Water pressure gauge	YOKOGAWA	MPM489	B86832	2023-01-04
6	Water pressure gauge	YOKOGAWA	MPM489	B86833	2023-01-04
7	Flowmeter	YOKOGAWA	AXG032	S5W920561039	2023-01-04
8	Anechoic rooms (hemi-anechoic rooms)	Guangzhou Kinte	-	NC-036-2	2023-10-07
9	AC source Supply	YANGHONG	YF-3600	VGDS-0637	2022-11-07
10	6 channel data logger	—	PXI-1033	VG DY-0257	2023-05-20
11	PULSE system	B & K	3660C	VG DY-0184	2023-04-12
12	Calibrator	B & K	4231	HJ-000095	2023-06-30
13	Long steel tape	—	5m	HJ-000150	2023-01-04
14	Temperature measurement system	—	—	NC-036-1	2023-06-07
15	Atmospheric pressure meter	—	—	HJ-000165	2022-11-22
16	Constant temperature water system	B & K	—	VGDS-0448	2023-04-18
17	Windscreen	B & K	WS002-5	—	—

-- End of Report --

Doc No.: ITC-TTW0902.02E -- Rev. 11